

SHARK 535Y

SHARK Y Branch

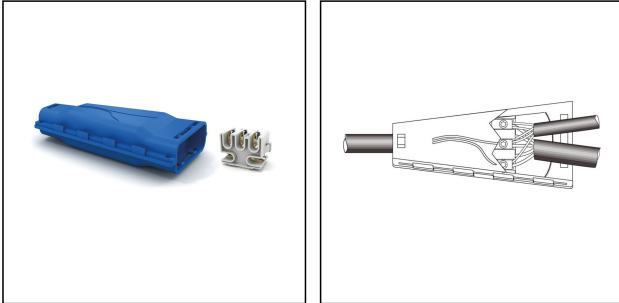

Products may differ in size, colour and appearance to those shown. If you require further information or customisation, please contact us directly.

Material	Polyamide
Filling	Silicone
Temp. range min	-20 °C
Temp. range max	90 °C
Glow wire test	self-extinguishing
Voltage	0,6 kV - 1 kV
Terminals/poles	max. 35 mm ²
Quantity of cable	2 - 5
Type	SHARK 535Y
UK-Number	SH6535/W
WISKA-Order no.	10108949
Packing unit	1
ETIM-Classification	EC001169

Remarks:

Cable Size: Main Cable 6 - 50 mm Branch cable 1.5 -25 mm

LxBxH: 260x130x65 mm

Description:

SHARK Y BRANCH Pre-filled gel insulated Y joint for branch connection.

Additional Info:

Ready to use, re-enterable, no mixing or pouring, immediate operation, excellent electrical insulation, good mechanical strenght, no expiry date.

28.04.2022

Your Contact:

WISKA UK Ltd.

Unit 7, Hurling Way · St. Columb Major Business Park · TR9 6SX, St. Columb Major, Cornwall · Great Britain

☎ +44-12-08816062 · 📠 +44-12-08816708

info@wiska.co.uk · www.wiska.co.uk

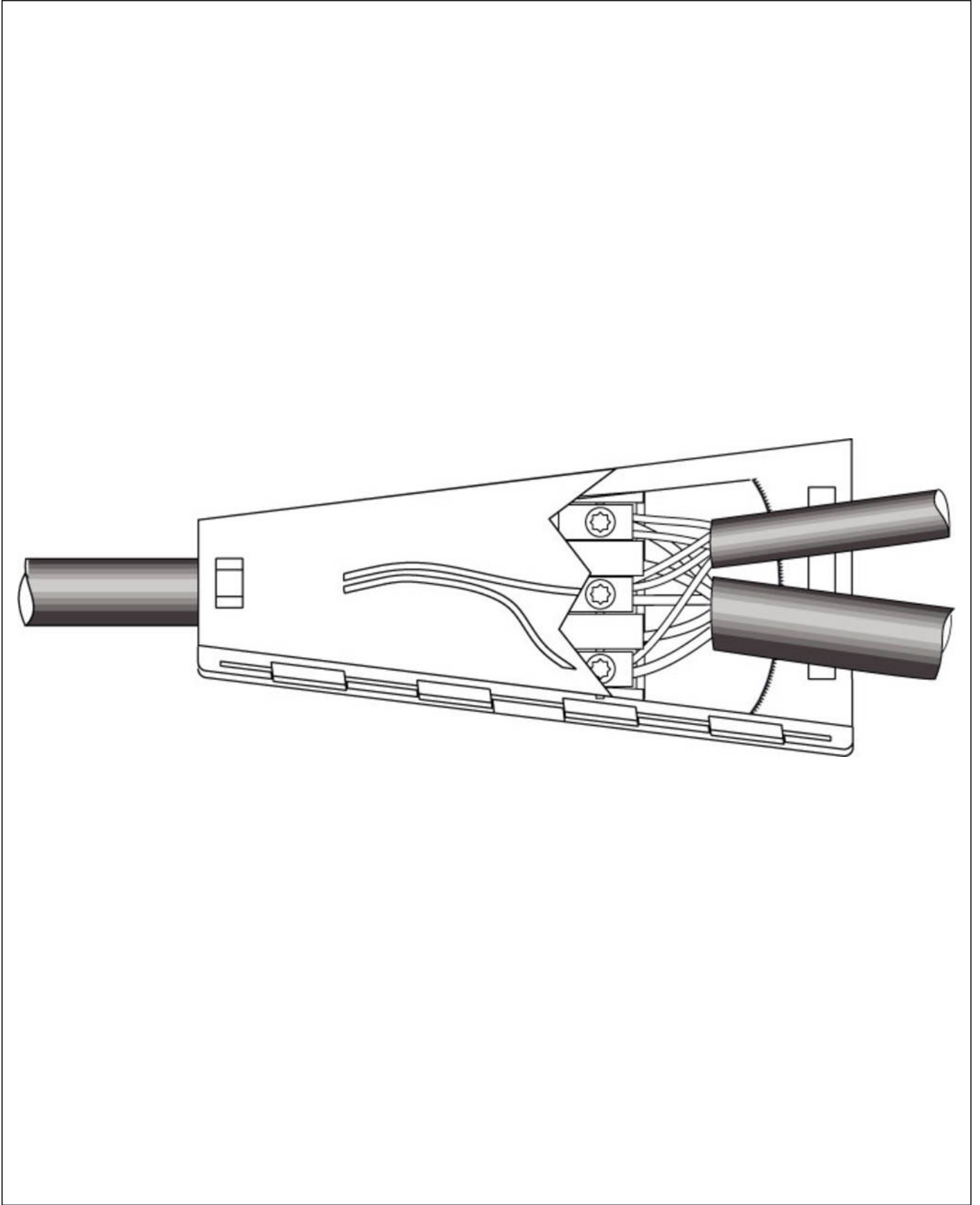

Your Contact:

WISKA UK Ltd.

Unit 7, Hurling Way · St. Columb Major Business Park · TR9 6SX, St. Columb Major, Cornwall · Great Britain

☎ +44-12-08816062 · 📠 +44-12-08816708

info@wiska.co.uk · www.wiska.co.uk